

VTC Series Vac-Mounts

Need Help Now?

Call 800-842-7284 or visit
www.ChicagoVibrator.com



Portable Mounts for Pneumatic Vibrators

VTC Series Vac Mounts

VTC Series Vac Mounts allow quick temporary mounting of pneumatic vibrators to a variety of flat or curved mounting surfaces, including rigid cardboard cartons, metal drums, trailers, railcars, ingredient bins, and other containers where weld-on or clamp-on vibrator mounts are not ideal or are prohibited.

A total of 8 VTC Series Vac Mount models combine with numerous vibrator types and models, providing options to suit a wide variety of applications.

Vibrators and air-prep components are sold separately. Air-prep components will vary depending on the vibrator model used. Please contact the Houston Vibrator Sales Team for assistance in selecting the combination of components that will best suit your intended use.

Standard Features & Benefits

- Mounts are pre-plumbed with supply lines and control valve
- Stout construction stands up to heavy use
- Integral safety cables
- Easy replacement of wear parts
- Quick to attach and remove from almost any surface

Available Accessories

- Mounting Hardware Kits
- Airline Lubricators, Filters, and Pressure Regulators
- Spare Suction Cups
- Pre-Assembly of Vibrator + VTC Mount

Also Available from Houston Vibrator:

- Foot-mounted Pneumatic Piston Vibrators
- Stud-mounted Pneumatic Piston Vibrators
- Rotary Pneumatic Vibrators in aluminum, stainless steel, cast iron, and high molecular plastic
- Rotary Electric Vibrators in standard materials and stainless steel
- Extensive selection of mounts and controls
- Custom Vibrating Tables for packaging

VTC Series Technical Data

Compatible Vibrators & Vessel Sizes

Model	Head Diameter		Air Consump.		Min Vessel Dia.		Weight	
	Rotary	Linear	CFM	L/min	in	mm	Lbs	Kgs
VTC-10S	GT4-10, GT-10SS K-8-10, DAR-2, R-50	FP12-18, FPLF12-18 FAL-18, VTL155-165	2.79	79	4.33	110	3.3	1.5
VTC-12S	GT8-25, GT16-25SS K8-25, DAR2-4, R50-80	FP25-35, FPLF25-35	2.79	79	13.78	350	6.6	3.0
VTC-15S	GT10-16, GT-16SS K8-16, DAR2-3, R50-65	FP12-35, FPLF12-35, VTL155-255, FAL18-25	2.79	79	29.92	760	5.5	2.5
VTC-15D	GT20-30, GT-25SS K20-36, DAR4, R-80	FP25-50, FPLF25-850, VFP75/01, VFP50/01, BV-150AC/BV-150IMP	5.58	158	29.92	760	9.9	4.5
VTC-20S	GT20-25, GT-25SS K20-25, R80	FP50-60, FPLF50-60 FAL35, VFP54/02	2.79	79	33.86	860	8.8	4.0
VTC-20D	GT30-36 DAR5, R100	FP60-95, FPLF60-95 BV-225AC/BV-225IMP	5.58	158	33.86	860	18.7	8.5
VTC-20T	-	VFP50/10	8.37	237	181.10	4600	39.7	18.0
VTC-20L	-	BV-312AC/BV-312IMP	8.37	237	33.86	860	35.3	16.0

General Arrangement (Sizes vary, please see additional pages)

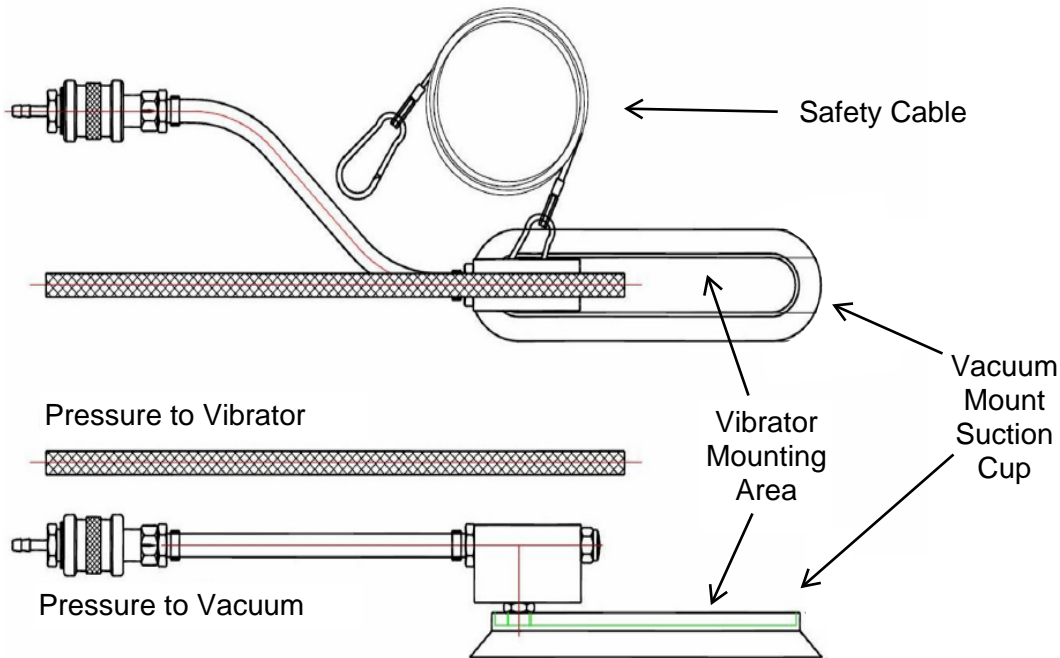

VTC Series Dimensions

Need Help Now?
Call 800-842-7284 or visit
www.ChicagoVibrator.com

VTC 10/12 S

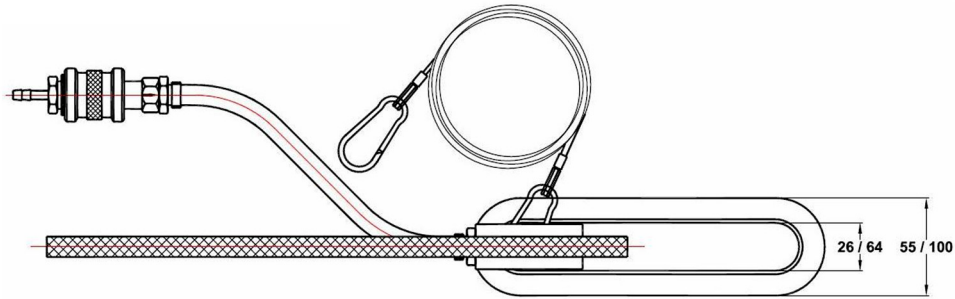

PRESSURE TO VIBRATOR



PRESSURE TO VACUUM

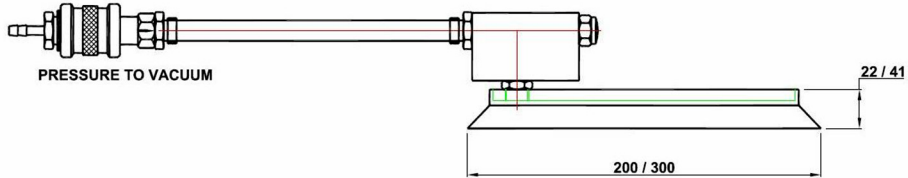

VTC 15/20 S

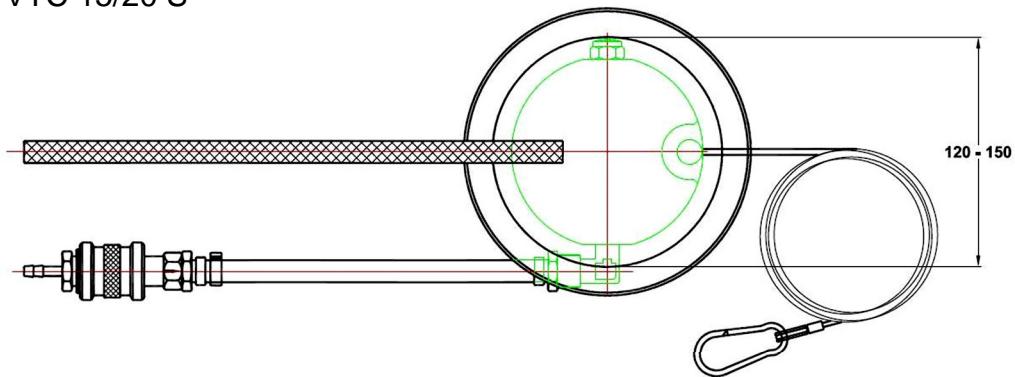

PRESSURE TO VIBRATOR



PRESSURE TO VACUUM

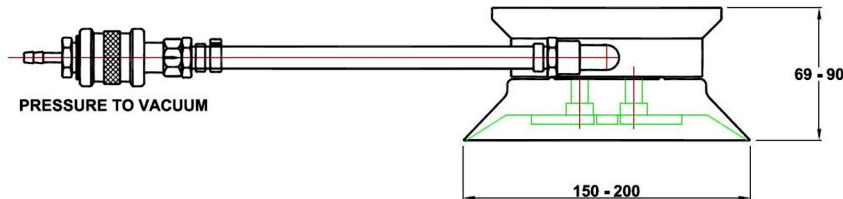

VTC Series Dimensions

VTC 15/20 D

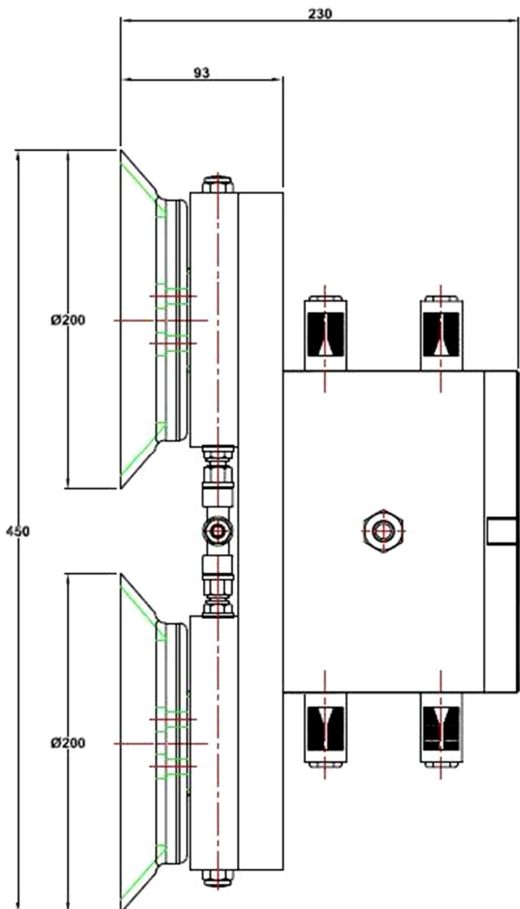
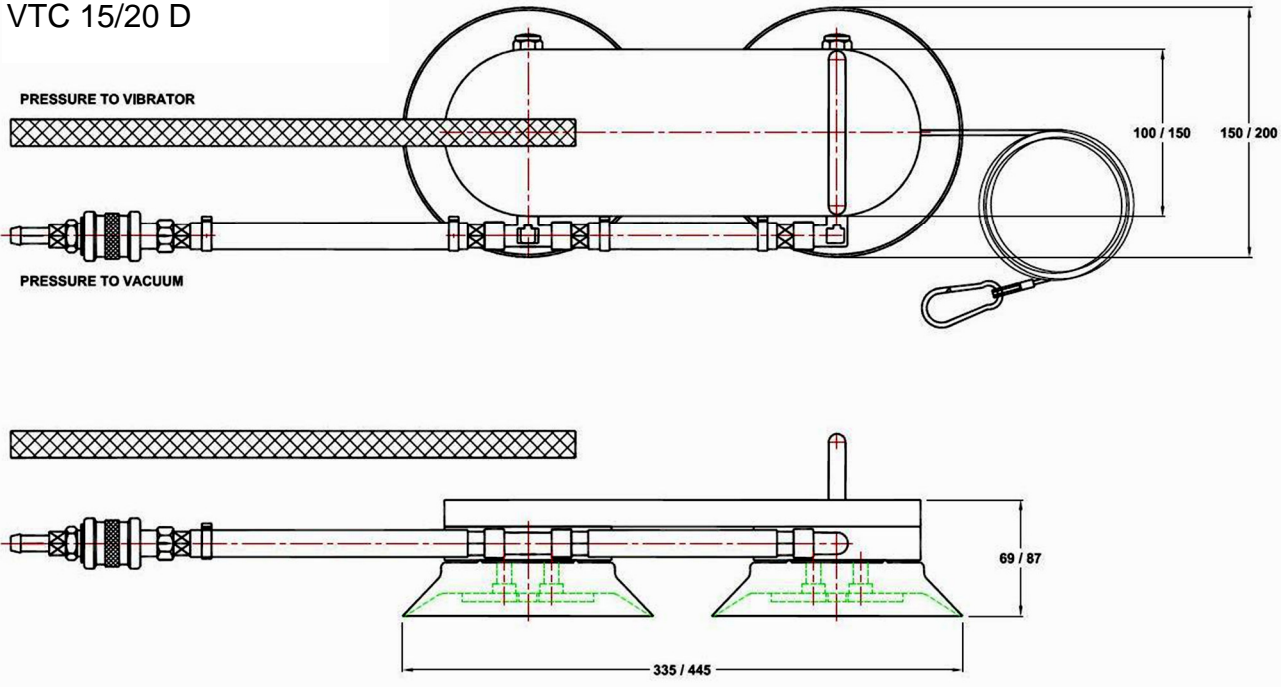

VTC 20 T

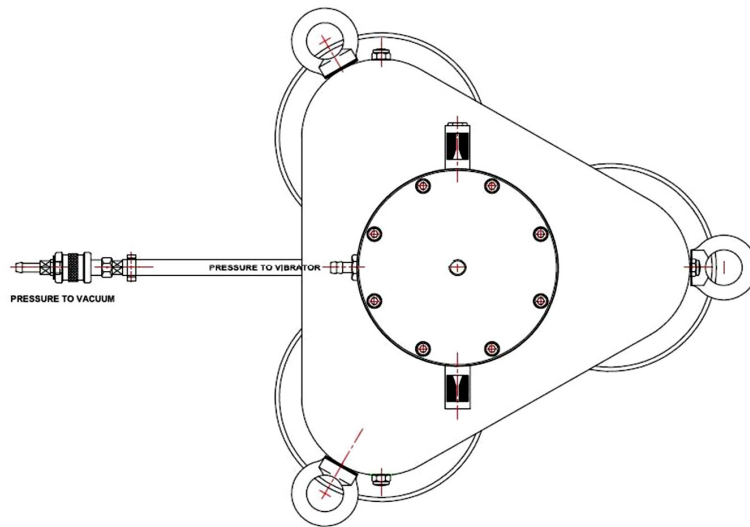

Distributed By:

ChicagoVibratorProducts
Flow and Compaction

Division of CVP Group

800-842-7284 (P)

866-247-7538 (F)

Solutions@ChiVib.com

www.ChicagoVibrator.com

