







## Selection Guide

Model Number	Body Length (ft)	Body Capacity (yd <sup>3</sup> )	Body Style
DC-3200 HT-3200	15-40	15-30	 Tandems/Live Bottoms/ Multi-axes to 40'
DC-3200 DC-2700	10-15	8-16	 Rear dump
DC-2500 DC-1600	9-10	5-10	 Rear dump
DC-2500 DC-1600	10-15	7-10	 Spreader body
DC-1600 DC-1000	8-9	2-5	 Rear dump
DC-1000 DC1-400	7-8	1-2	 Concrete pumps Bins/Hoppers/Chutes
DC-80	NA	1	 Spreader on pickup truck bed

## Typical Installation

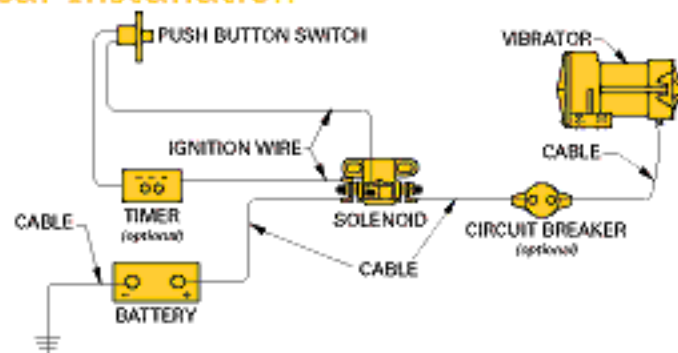

## Installation Kits

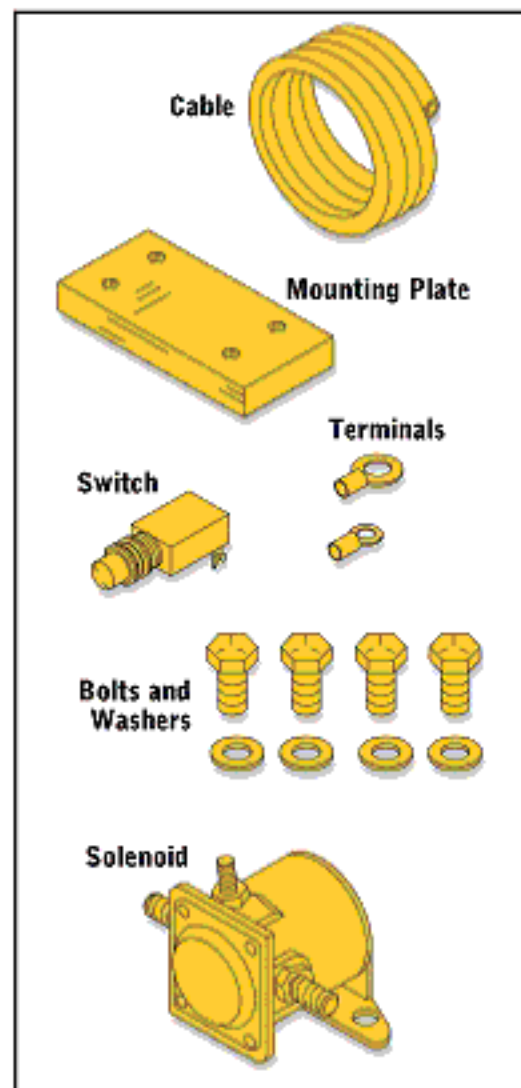

Installation kits are shipped standard with the DC-1000 through the DC-3200. Each "DC" installation kit includes 25' of cable (40' w/ the DC-3200), mounting plate, bolts, washers, switch, solenoid, terminals, and installation instructions. Installation kits for the DC-80 and DC1-400 include mounting bolts and washers. Circuit breakers (optional) are recommended for all "DC" vibrators.

The HT-3200 installation kit includes a mounting plate, bolts, and washers.

## Performance

### 12V

Model	Amps	Max.RPM	Force lbs.	Offset wt.
DC-3200	85	4000	3200	7.0 in.lb.
DC-2700	75	4500	2700	4.7 in.lb.
DC-2500	72	5000	2500	3.5 in.lb.
DC-1600	70	5000	1600	2.3 in.lb.
DC-1100	70	5000	1100	1.5 in.lb.
DC-1000	22	5000	1000	1.4 in.lb.
DC1-400	15	3800	410	1.0 in.lb.
DC-80	5	4000	80	.18 in.lb.

### 24V

Model	Amps	Max.RPM	Force lbs.	Offset wt.
DC-3200	62	4000	3200	7.0 in.lb.
DC-2700	55	4500	2700	4.7 in.lb.
DC-2500	55	5000	2500	3.5 in.lb.
DC-1600	55	5000	1600	2.3 in.lb.
DC-1100	55	5000	1100	1.5 in.lb.
DC-1000	11	5000	1000	1.4 in.lb.
DC1-400	7.5	3800	410	1.0 in.lb.

Model	Max GPM/PSI	4000	3200	7.1 in.lb.
HT-3200	5.6/1500			

## Specifications and Dimensions\*

### DC

Model	Dimensions								Foot Dim.		Bolt (Qty.)	Weight lbs.
	A	B	C	D	E	F	G	H	K	L	M	
DC-3200	10 <sup>3</sup> / <sub>8</sub>	9 <sup>3</sup> / <sub>4</sub>	6 <sup>7</sup> / <sub>8</sub>	1 <sup>3</sup> / <sub>16</sub>	3 <sup>5</sup> / <sub>8</sub>	2	2 <sup>9</sup> / <sub>16</sub>	5 <sup>1</sup> / <sub>4</sub>	2	8	5/8 x 1 <sup>3</sup> / <sub>4</sub> (4)	36
DC-2700	10	9 <sup>3</sup> / <sub>4</sub>	6 <sup>7</sup> / <sub>8</sub>	1 <sup>3</sup> / <sub>16</sub>	2 <sup>1</sup> / <sub>4</sub>	1 <sup>3</sup> / <sub>4</sub>	2 <sup>9</sup> / <sub>16</sub>	5 <sup>1</sup> / <sub>4</sub>	8	8	5/8 x 1 <sup>3</sup> / <sub>4</sub> (2)	32
DC-2500	10	9 <sup>3</sup> / <sub>4</sub>	6 <sup>7</sup> / <sub>8</sub>	1 <sup>3</sup> / <sub>16</sub>	2 <sup>1</sup> / <sub>4</sub>	1 <sup>3</sup> / <sub>4</sub>	2 <sup>9</sup> / <sub>16</sub>	5 <sup>1</sup> / <sub>4</sub>	8	8	5/8 x 1 <sup>3</sup> / <sub>4</sub> (2)	31
DC-1600	10	9 <sup>3</sup> / <sub>4</sub>	6 <sup>7</sup> / <sub>8</sub>	1 <sup>3</sup> / <sub>16</sub>	2 <sup>1</sup> / <sub>4</sub>	1 <sup>3</sup> / <sub>4</sub>	2 <sup>9</sup> / <sub>16</sub>	5 <sup>1</sup> / <sub>4</sub>	8	8	5/8 x 1 <sup>3</sup> / <sub>4</sub> (2)	30
DC-1100	10	9 <sup>3</sup> / <sub>4</sub>	6 <sup>7</sup> / <sub>8</sub>	1 <sup>3</sup> / <sub>16</sub>	2 <sup>1</sup> / <sub>4</sub>	1 <sup>3</sup> / <sub>4</sub>	2 <sup>9</sup> / <sub>16</sub>	5 <sup>1</sup> / <sub>4</sub>	8	8	5/8 x 1 <sup>3</sup> / <sub>4</sub> (2)	30
DC-1000	9	9 <sup>3</sup> / <sub>4</sub>	6 <sup>1</sup> / <sub>2</sub>	1	2 <sup>1</sup> / <sub>4</sub>	2 <sup>1</sup> / <sub>4</sub>	2 <sup>1</sup> / <sub>2</sub>	3 <sup>7</sup> / <sub>8</sub>	8	8	1/2 x 1 <sup>1</sup> / <sub>2</sub> (2)	23
DC1-400	9 <sup>1</sup> / <sub>16</sub>	6 <sup>3</sup> / <sub>8</sub>	5 <sup>9</sup> / <sub>16</sub>	1 <sup>1</sup> / <sub>8</sub>	6 <sup>1</sup> / <sub>4</sub>	2 <sup>3</sup> / <sub>4</sub>	1 <sup>15</sup> / <sub>16</sub>	4 <sup>1</sup> / <sub>4</sub>	3 <sup>3</sup> / <sub>4</sub>	5	3/8 x 1 <sup>1</sup> / <sub>2</sub> (4)	18
DC-80	5 <sup>1</sup> / <sub>16</sub>	5	3 <sup>7</sup> / <sub>16</sub>	1/2	3	1 <sup>13</sup> / <sub>16</sub>	1 <sup>9</sup> / <sub>16</sub>	2 <sup>11</sup> / <sub>16</sub>	2	4	3/8 x 1 <sup>1</sup> / <sub>4</sub> (4)	5

### Hydraulic

HT-3200	9 <sup>1</sup> / <sub>16</sub>	9 <sup>3</sup> / <sub>4</sub>	5 <sup>7</sup> / <sub>16</sub>	1 <sup>1</sup> / <sub>4</sub>	3 <sup>3</sup> / <sub>4</sub>	2 <sup>1</sup> / <sub>16</sub>	2 <sup>1</sup> / <sub>2</sub>	2 <sup>7</sup> / <sub>8</sub>	2	8	5/8 x 1 <sup>3</sup> / <sub>4</sub> (4)	30
---------	--------------------------------	-------------------------------	--------------------------------	-------------------------------	-------------------------------	--------------------------------	-------------------------------	-------------------------------	---	---	---	----

\*In inches

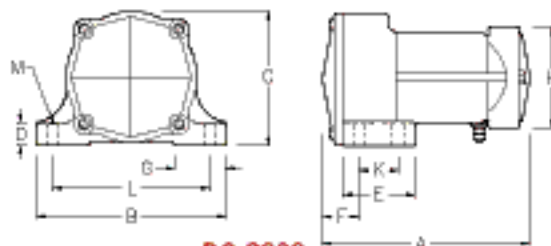

DC-3200



DC-1000, DC-1100, DC-1600, DC-2500, DC-2700



DC1-400

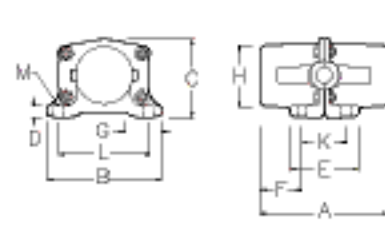

DC-80

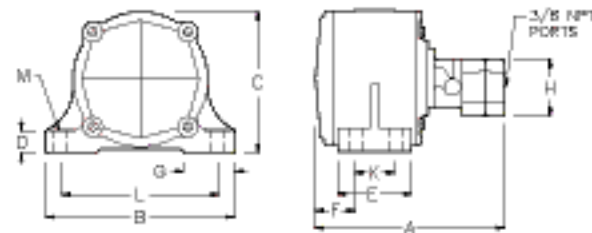

HT-3200

### Optional Equipment

- Cable (by the foot)
- Circuit breaker
- Timer
- Timer enclosure
- Continuous duty kit (DC-80, DC1-400, DC-1000)

### Ordering Information

When ordering please specify:

- Vibrator model number
- 12V or 24V preference
- Aluminum or steel truck body